

Technische Zeichnung

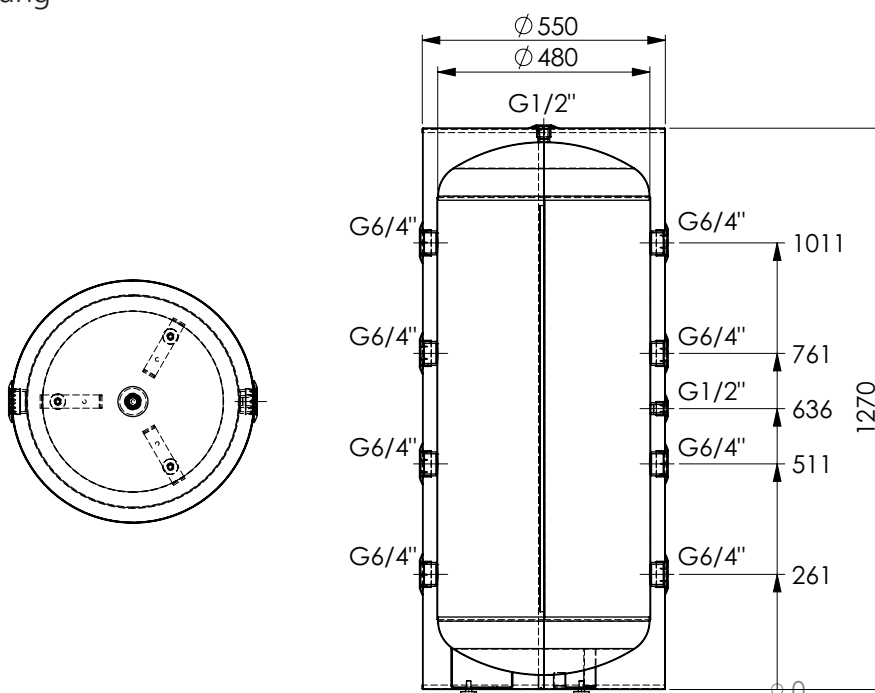

Technische Tabelle

Speichervolumen	Liter	200
Max. Betriebstemperatur	°C	95
Warmhalteverlust	W	64
Prüfdruck	bar	6
Max. Betriebsdruck	bar	3
Gewicht	Kg	56